

COZY **N** SAFE®

a R T H u R



Instruction Manual

INSTRUCTION MANUAL

Birth – 36kg (Approx. Birth – 11 years)

Model: EST 528

Group: 0+/1/2/3

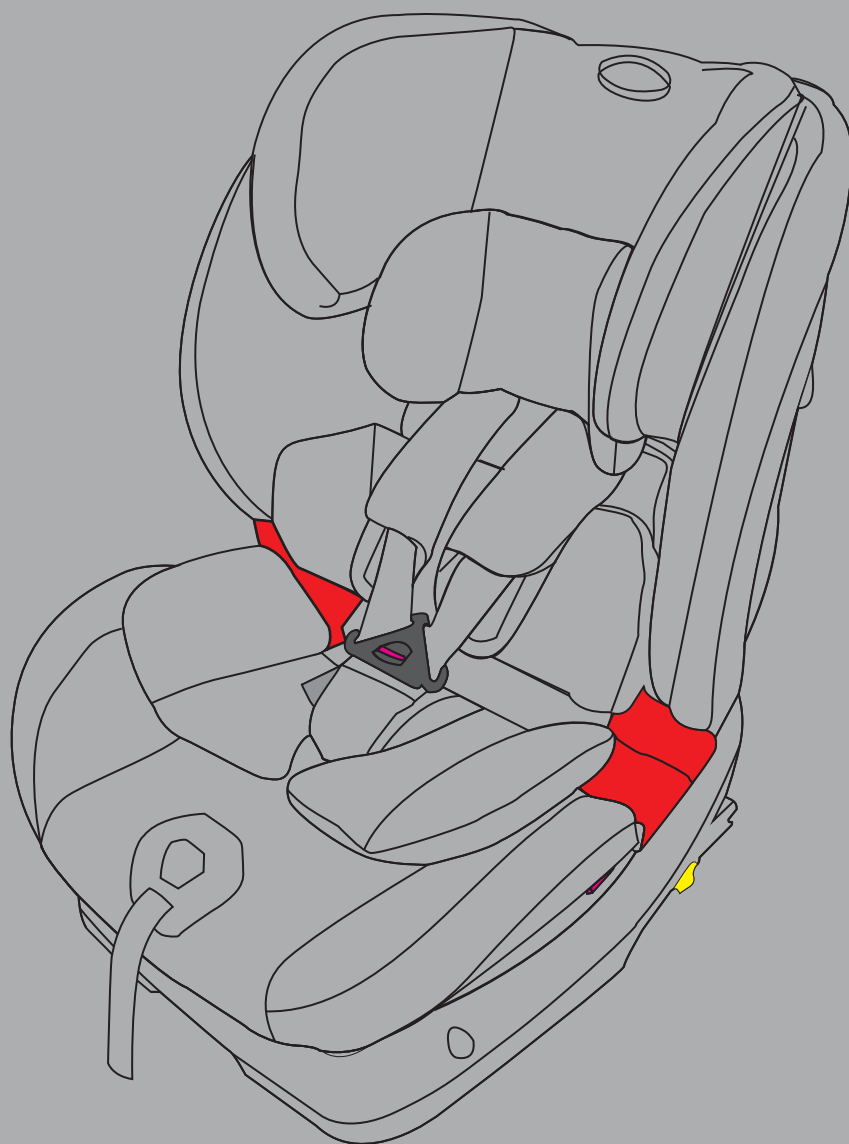

Please read this manual carefully before use

COZYNSAFE



PARTS

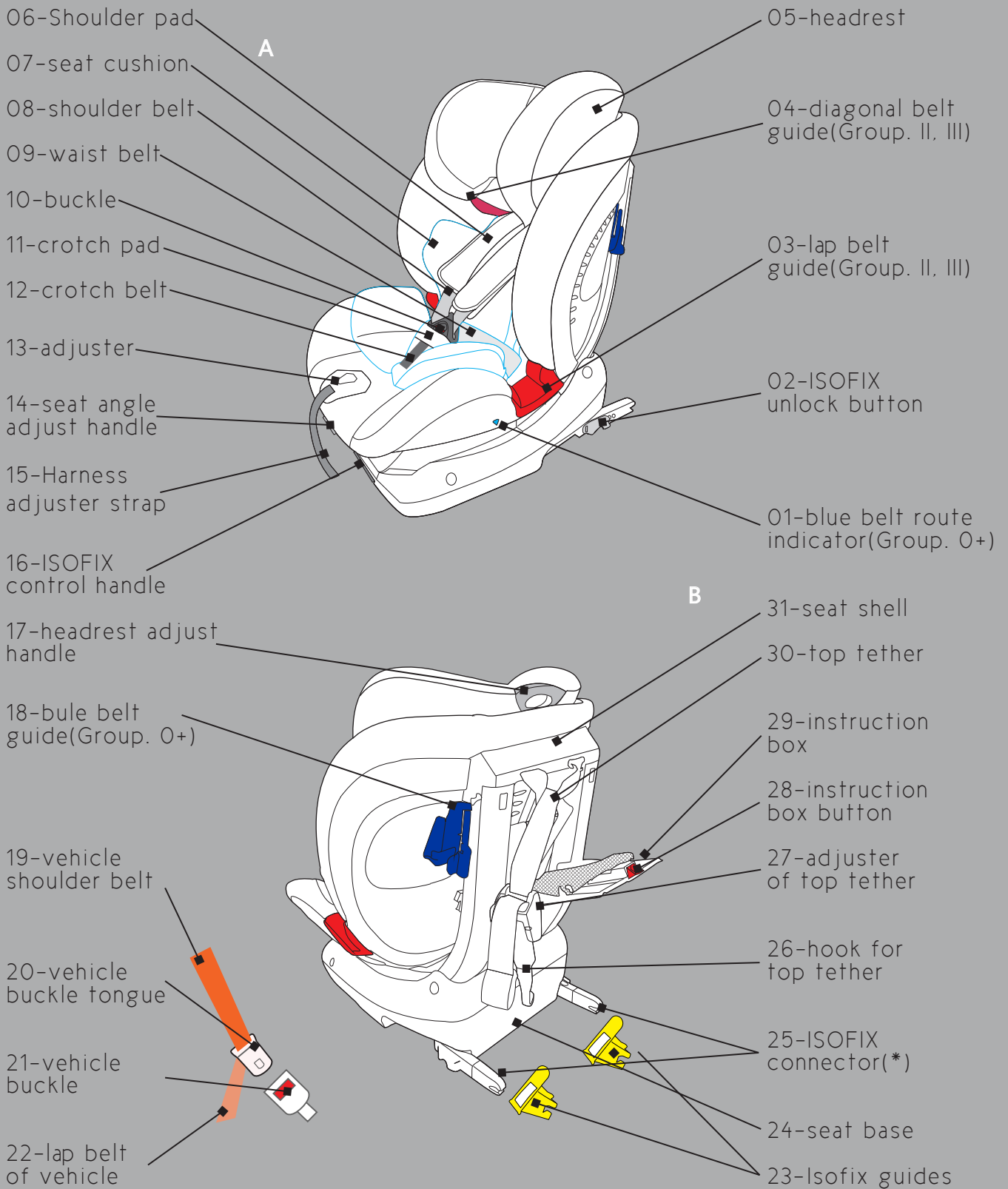







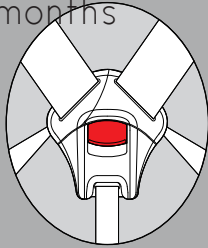
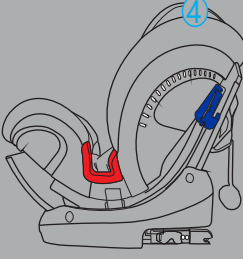
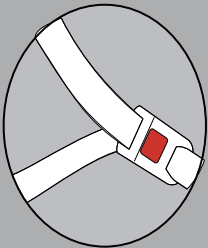

*when used as Semi-universal Group. II, III, these connectors mean: Additional Attachment (FIX)

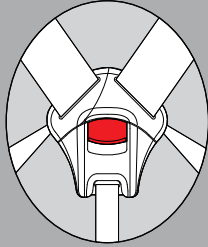
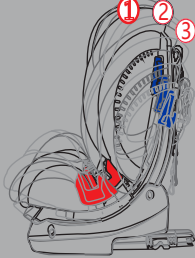
COZYNSAFE

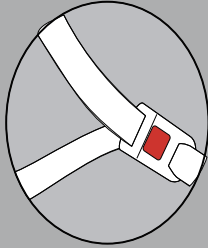
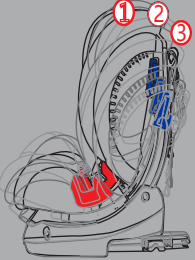

suitable weight and installation methods summary

Group	weight	direction of installation	child fix method	seat angle	fix method for seat
0+	0-13kg Birth - 15 months	rearward facing	5 point harness	position 4 (most recline)	Vehicle 3 point belt
			 15 months		
I	9-18kg 9 months - 4 years	forward facing	5 point harness	position 1,2,3	ISOFIX+ TOPTETHER
					
II+III	15-36kg 3-11 years	forward facing	Vehicle point belt	position 1,2,3	Vehicle 3 point belt (FIX is optional)
					Main method  (optional method)  + 

NOTICE (1)

1. When this CRS is used in group 0+/2+3 for child (0-13kg/15-36kg) and only fasten by 3-point safety belt, This is a "Universal" child restraint. It is approved to Regulation No. 44, 04 series of amendments, for general use in vehicles and it will fit most, but not all car seats.
2. A correct fit is likely if the vehicle manufacturer has declared in the vehicle handbook that the vehicle is capable of accepting a "Universal" child restraint for this age group.
3. This child restraint has been classified as "Universal" under more stringent conditions than those which applied to earlier designs which do not carry this notice.
4. If in doubt, consult either the child restraint manufacturer or the retailer.

NOTICE (2)

1. When used in group I for child 9kg – 18kg, this is an ISOFIX CHILD RESTRAINT SYSTEM. It is approved to Regulation No. 44, 04 series of amendments for general use in vehicles fitted with ISOFIX anchorages systems.
2. It will fit vehicles with positions approved as ISOFIX positions (as detailed in the vehicle handbook), depending on the category of the child seat and of the fixture.
3. The intended mass group and the ISOFIX size class for this device is: Group 1 (9kg-18kg), B1 (page2).
4. If you have any doubt please contact manufacturer or retailer.

NOTICE (3)

When this child restraint is used in group 2+3 for child 15kg – 36kg and not only fasten by 3-point safety belt but also with the ISOFIX Attachment, This child restraint is classified for "(Semiuniversal)" use and is suitable for fixing into the seat positions of the following cars:

CAR	FRONT	REAR
(Model)	Outer	Centre
	Yes	Yes No

COZYSAFE



CONTENT

1. Introduction.....	05
2. Suitability.....	05
3. General safety instructions.....	06
4. Adjustments.....	08
4.1 Remove and reset the seat cushion.....	08
4.2 Adjusting the recline position.....	08
4.3 Adjusting the crotch belt.....	09
4.4 Adjust the harness and headrest height.....	09
5. Seat selection and adjustment.....	10
5.1 Adjusting the car seat.....	10
5.2 Seat for universal installation.....	10
5.3 Seat for semi-universal installation.....	11
5.4 Seat for ISOFIX-universal installation.....	11
6. Installation in vehicle.....	11
6.1 Universal installation in vehicle with 3point belt for Group 0+.....	11
6.2 Semi-universal installation in vehicle with FIX.....	13
6.3 ISOFIX-universal installation in vehicle with ISOFIX and top tether.....	14
7. Securing the child.....	15
7.1 Securing the child in group 0+(0 – 13 kg), I (9 – 18 kg).....	15
7.2 Securing the child in groups II+III (15 – 36 kg).....	16
8. Removing and replacing the cover.....	19
9. Washing and maintenance.....	19
9.1 Fabric.....	19
9.2 Belt and plastic.....	19
9.3 Buckle.....	19
10. Steps to take after an accident.....	20
11. Warranty.....	20
12. Fit list.....	21



Instruction manual

1. Introduction

We are happy that you have decided on the Arthur as your choice for a child restraint system.

To gain the most comprehensive protection for your child, the seat must be used exactly as described in this manual.

Please read this instruction manual carefully before use. It is most important that these instructions remain with the car seat at all times.

You can store these instructions in the instruction box provided on the rear of the backrest of your seat. Push down the button and pull back to open the box. (fig.1)

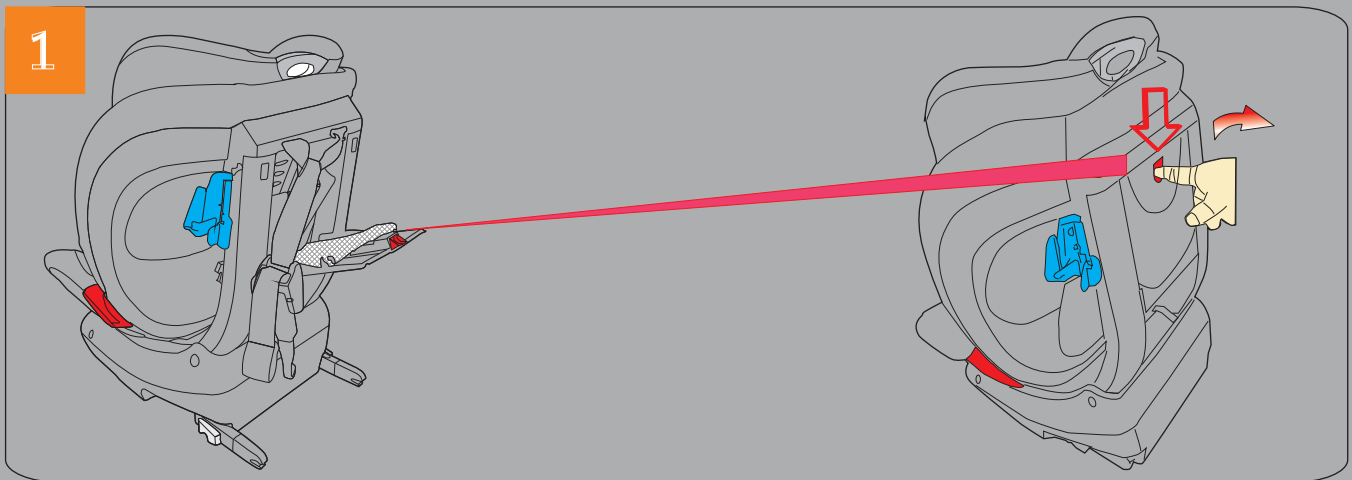

2. Suitability

The seat has been tested and approved according to the newest version of the ECE-R44/04 regulation. It is approved with the "universal", "semi-universal" and "ISOFIX universal" classes during different age stages.

The seat child restraint system is suitable for weight classes 0+, I, II and III, i.e. for children weighing between 0 and 36kg (approximately birth to 11 years) or up to a height of 150 cm.

Age Groups (Weight Classes):

Group 0+ : 0 kg – 13 kg

Group I : 9 kg – 18 kg

Group II+III : 15 kg – 36 kg

For children weighing 0–18kg (corresponding to ages of approximately birth to 4 years), the 5 point harness system must be used. Please observe the proper use of the harness system (see Section 7.1).

For use in your vehicle, please also follow the car manufacturer's manual, or contact your car dealer.

COZYNSAFE



3. General safety instructions

If it is the first time using the child restraint system, Please read the entire instruction manual thoroughly before installation. In any case improper installation can endanger the life of your child.

Make sure the child restraint system is properly installed with your child, prior to the trip. Do not attempt to make any adjustments during driving.

"Only suitable if the approved vehicles are fitted with 3 point with retractor safety-belts, approved to UN/ECE Regulation No. 16 or other equivalent standards."

The rigid items and plastic parts of a child restraint must be so located and installed that they are not liable, during everyday use of the vehicle, to become trapped by a movable seat or in a door of the vehicle.

Airbags can cause injury. Do not use this child seat on a passenger seat fitted with a frontal airbag.

Any straps holding the restraint to the vehicle should be tight, that any straps restraining the child should be adjusted to the child's body, and that straps should not be twisted.

It is very important to ensure that any lap strap is worn low down, so that the pelvis is firmly engaged.

The child restraint system should be changed when it has been subject to violent stresses in an accident.

Do not making any alterations or additions to the device without the approval of the competent authority, and it is dangerous to not follow the installation instructions provided by the child restraint manufacturer.

When the child restraint system is not provided with a textile cover, it shall be recommended that the chair should be kept away from sunlight, otherwise it may be too hot for the child's skin.

Never leave your child unattended in the child restraint system even for a short time.

Ensure that any luggage or other objects liable to cause injuries in the event of a collision shall be properly secured.

COZYNSAFE
EST. 2017



The child restraint must not be used without the cover provided.

The seat cover should not be replaced with any other than the one recommended by the manufacturer, because the cover constitutes an integral part of the restraint performance.

Your car seat must be positioned and installed properly so that, under normal vehicle usage conditions, no part can become jammed under or between any moveable seat or in the vehicle door.

If there is a interference between the adult safety-belt buckle and child restraint system, it is an unsatisfactory position of the adult safety-belt buckle relative to the main load bearing contact points on the restraint. You shall be advised to contact the child restraint manufacturer if in doubt about this point.

Do not use any load bearing contact points other than those described in the instructions and marked in the child restraint.

When you use this child restraint system at Group. I, and fix the seat by ISOFIX you must read the car manufacturer's handbook.

COZYNSAFE
BY TRUMPF



4. Adjustments

4.1. Remove the seat cushion

The seat must be used for children from 0 to 13kg (approximately birth to 9 months) with the seat cushion (Fig. 2).

Once your child 's weight is between 9kg to 36kg (approximately 15 months to 11 years), you must remove it.

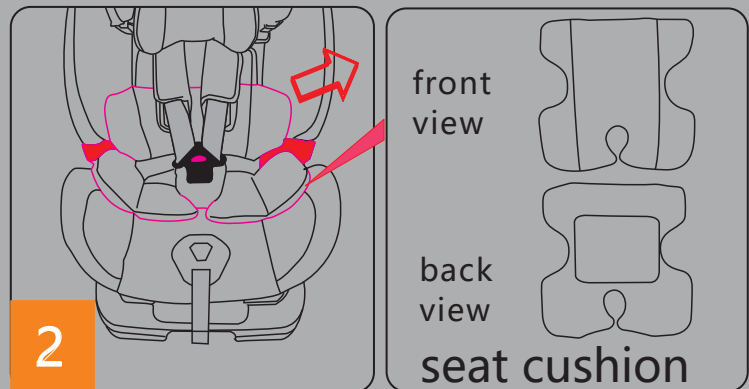

4.2 Adjusting the recline position

The child seat can be adjusted to different angles. Method as below: (Fig. 3, 4)

4.2.1. Using one hand press on the front of the seat and pull back the seat angle adjust handle.

4.2.2. Move in the direction of the arrow, backward and forward to adjust the angle.

4.2.3. Release the handle when the seat is at the right angle.

⚠️ "IMPORTANT - DO NOT USE FORWARD FACING BEFORE THE CHILD'S WEIGHT EXCEEDS 9KG."

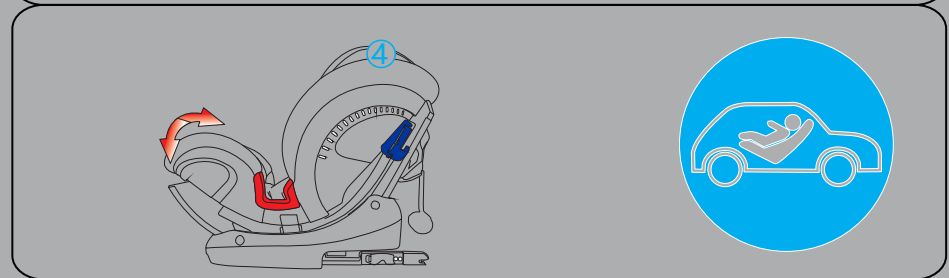
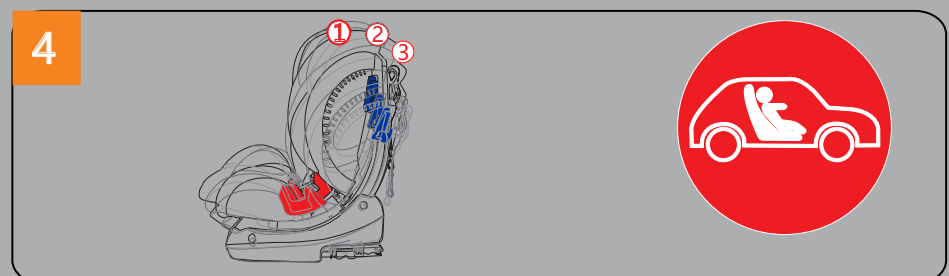
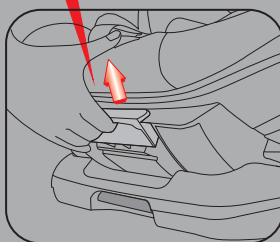
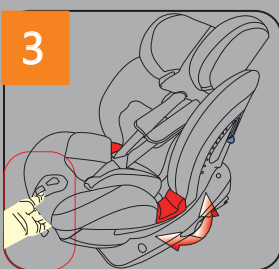

COZYNSAFE



4.3. Adjusting the crotch belt

The crotch belt is positioned at the inner slot. When you feel that the crotch belt is too tight for your child. Please adjust as follow: (Fig. 5, 6)

4.3.1. Pull up the cover at the front of your seat, Pinch the crotch belt (part no.12 page 01) and push down.

4.3.2. Then twist it through to the inner slot.

4.3.3. Adjust the belt to ensure that the crotch belt is not twisted.

4.3.4. After adjusting, pull and push it several times to confirm it is fixed.

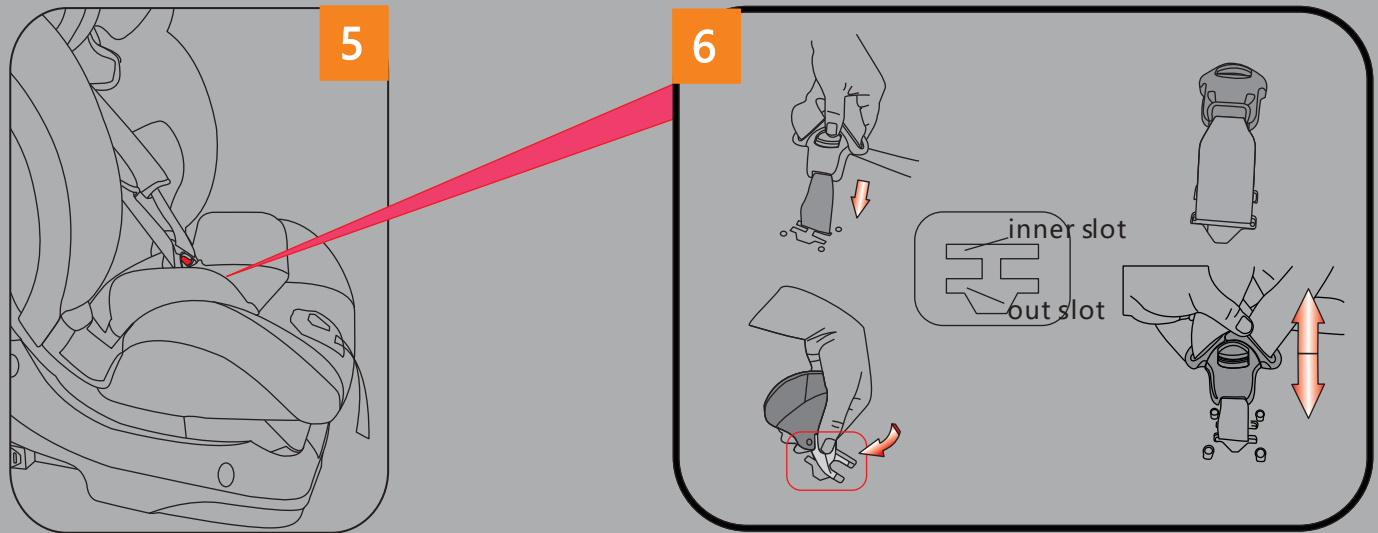

4.4. Adjust the harness and headrest height

Notice: The child seat's harness has 9 height positions. The top of the shoulder belt must be parallel or a little higher than the child's shoulders. This will provide the effective protection for your child in the event of a collision.

Follow the step bellow:

4.4.1. Relax the harness before adjusting the height. The harness is loosened by pressing the adjuster on the front of the seat. Press down the adjuster as you grip the two shoulder straps with your other hand. Pull the shoulder straps towards you to loosen the harness. (Fig. 7)

4.4.2. Insert one hand into the ring of the headrest adjust handle on the top of the headrest and hold on. At the same time using your thumb press on the top of the headrest. (Fig. 8)

4.4.3. Pull up and push down the headrest to adjust the height. (Fig. 8)

Then relax your hand when the headrest is at the suitable position for your child. Pull and push again to ensure that the headrest is locked in place. (Fig. 8)

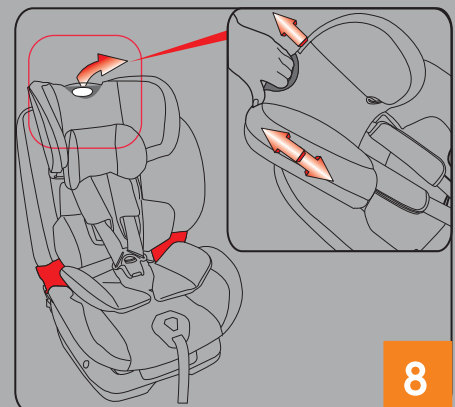
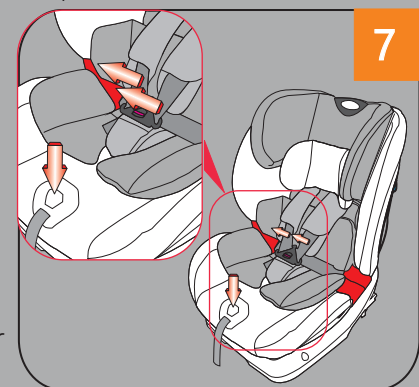

5. Seat selection and adjustment

5.1 Adjusting the car seat

If the installation is restricted by the vehicle headrest then it must be moved to the highest position or removed. (Fig. 9)

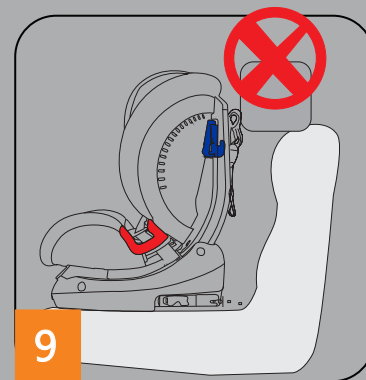

Adjust the seat to the right position, place it on the vehicle seat forward facing and make sure the backrest of seat is firmly pressed against the backrest of vehicle seat. (Fig. 10)

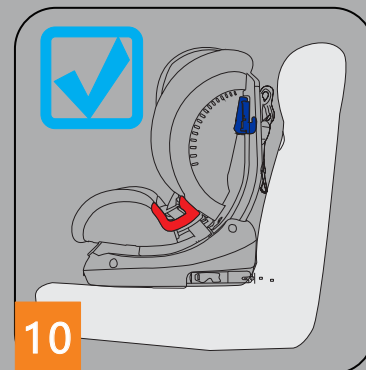

5.2 Seat for universal installation for (Group. 0+, II, III)

The child restraint system seat can be installed in vehicles on any seat suitable for use in the listed vehicles fitted with 3 point with retractor safety-belts, approved to ECE Regulation No. 16 or other equivalent standards. (Fig. 11)

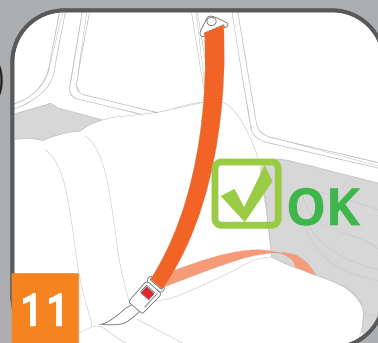

And must not at any time be fitted using only a 2 point lap belt. (When used in Group 0+ and Group II+III (Fig. 12).



If the car manufacturer allows child restraint systems on the passenger seat, the seat should be moved to the position furthest back. (Fig. 13)

⚠ WARNING: Airbags can cause injury. Do not use this child seat on a passenger seat fitted with a frontal airbag.

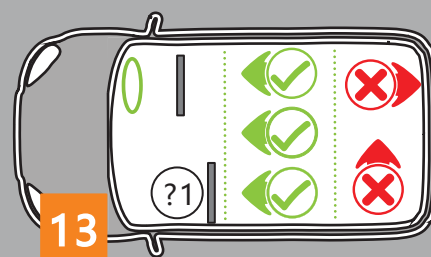

We suggest always to install this child seat at the rear seat of the vehicle. This will be safer for your child.



5.3. Seat for semi-universal installation for (Group. II, III)

Semi-universal installation of the child restraint system is only possible on car seats fitted with ISOFIX anchors. With the aid of the ISOFIX connectors, the seat can be securely fastened to the body of the vehicle by using these ISOFIX anchor points.

5.4. Seat for ISOFIX-universal installation for (Group. I)

ISOFIX-universal installation of the child restraint system is only possible on car seats fitted with ISOFIX anchors and top tether anchor. With the aid of the ISOFIX connectors and top tether anchor, the seat can be securely fastened to the body of the vehicle by using these ISOFIX anchor points and top tether anchor point.

6. Installation in vehicle

6.1. universal installation in vehicle with 3 point belt for Group. 0+

WARNING: Airbags can cause injury. Do not use this child seat on a passenger seat fitted with a frontal airbag.



! IMPORTANT:

Always use the rear seats of your vehicle even if your highway code permits the use on the front seat. Check your highway code as this regulation may vary according to the country. It is better to assemble your seat at the side pavement or on a driveway.

IMPORTANT – DO NOT USE FORWARD FACING BEFORE THE CHILD’S WEIGHT EXCEEDS 9KG.

(We recommend to try to extend the use of age and weight to use the rear facing position until your child’s weight is more than 13kg).

6.1.1. Seat angle adjust: Refer to (fig.14) to adjust the seat to the most recline position (position 4).

6.1.2. Seat installation: Place the child seat to the rear seat in the vehicle, ensure that the bottom of the seat is against the vehicle seat and the front of the seat touches the vehicle seat backrest. (fig. 15)

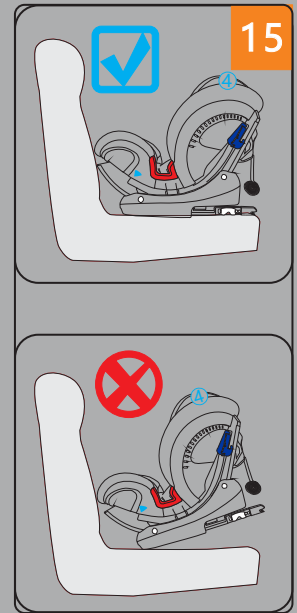
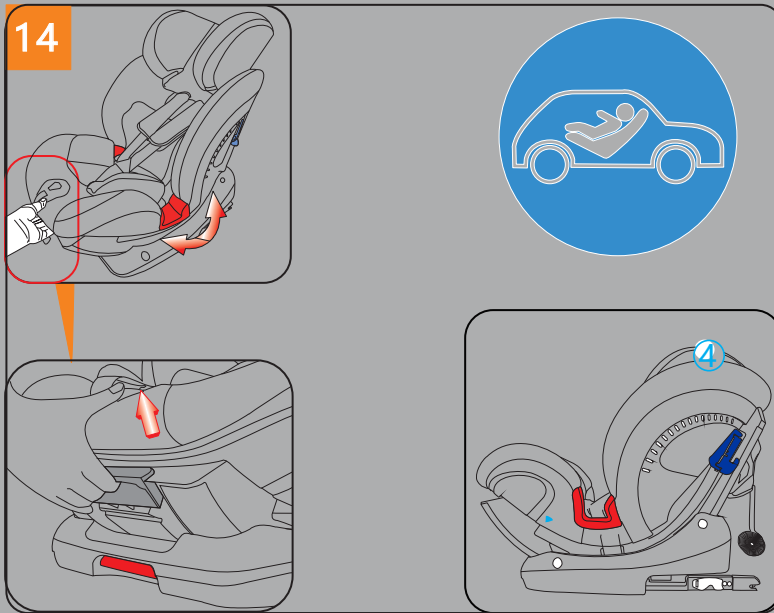

6.1.2.1. Extend the vehicle belt to its fullest, Insert it from the slot at the side of the seat, then through out at the another side. (fig. 16)

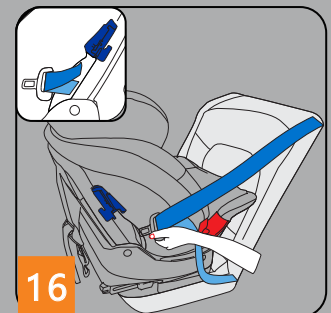

6.1.2.2. Insert the buckle tongue into the vehicle buckle, and hear a "click". (fig. 17)

6.1.2.3. Insert the diagonal belt into the blue belt guide at the vehicle buckle side.

6.1.2.4. Repeat the same method on the other side.

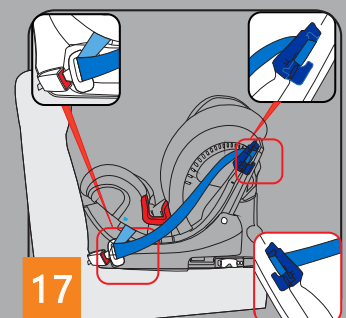

COZYNSAFE



6.1.2.5. Pull the diagonal belt at the top of the vehicle buckle to make sure that the belt is tight. (fig. 18)

6.1.2.6. Then pull the diagonal belt at the top of the seat as indicated by the arrow, as tight as you can.. As tight as you can. (fig. 19)

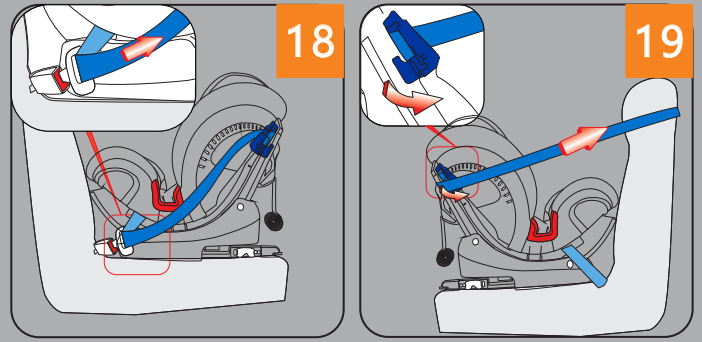

⚠ IMPORTANT: Misuse of the child car seat will reduce the protection that the seat provides.

Check that the belt is at the right position, is tight enough at all positions and ensure that there are no twists in the belt.

6.1.3. Installation of child: Refer the section 7.1 to fix your child carefully to finish the installation.

Finally check the child seat is fitted stable on the vehicle seat. If you find any movement you must tighten the belt again until the child seat is tight enough.

6. 2 Semi-universal installation in vehicle with FIX

6.2.1. First stick both insert guides onto the ISOFIX anchor fittings between the seat and backrest of the vehicle seat. (Fig. 20).

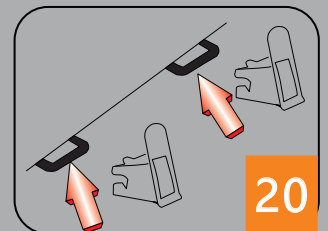

6.2.2. Now using one hand grab the ISOFIX control handle at the lower part of the base, and pull outward (Fig. 21). The ISOFIX connectors will now automatically extend from the back of the seat base.

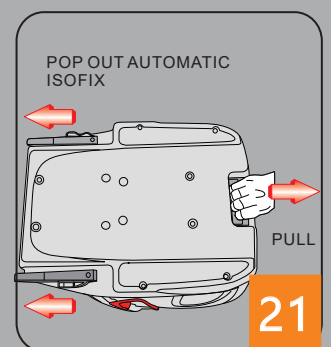

Test whether the connector hooks are opened by pushing the ISOFIX unlock button forward (Fig. 22).

When the ISOFIX unlock button shows the "red colour", the connector hooks are open.

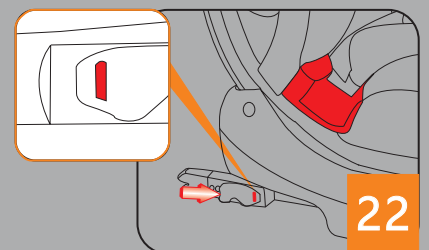

6.2.3 Then place the seat on a vehicle seat and push both ISOFIX connectors onto the metal brackets (ISOFIX anchor points) and press firmly against it so that the connectors lock in place (Fig. 23).

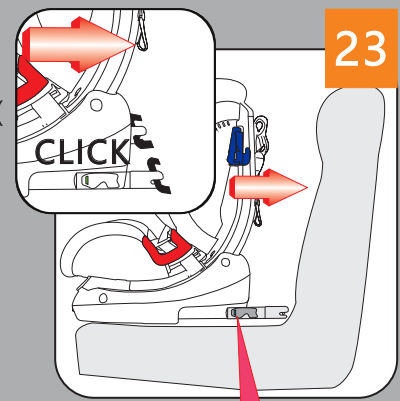

The correct locking will be confirmed when the "green colour" shows on the ISOFIX unlock button on both side (Fig 24).

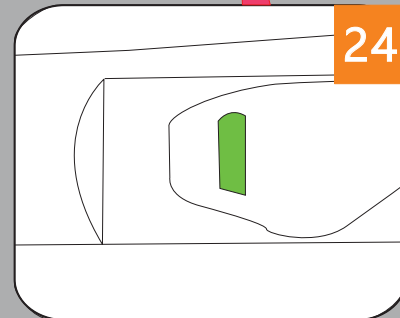

Test whether the ISOFIX connectors are closed by jerking on the seat shell and check if the lock is engaged.

6. 3 ISOFIX-universal installation in vehicle with ISOFIX and top tether

6.3.1. Secure the ISOFIX to the vehicle ISOFIX anchor (section 6.2).

6.3.2. Top tether installation

6.3.2.1. Push down the instruction box button, pick the top tether and put it to the front of the child seat. (fig. 25)

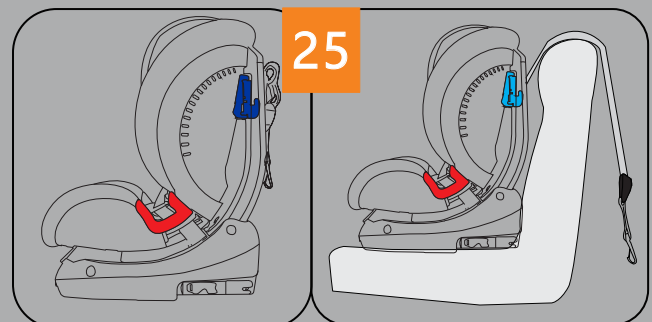

6.3.2.2. Push down the button on the top tether adjuster and at the same time pull the belt at anchor point side near the child seat to lengthen the top tether strap. (fig. 26)

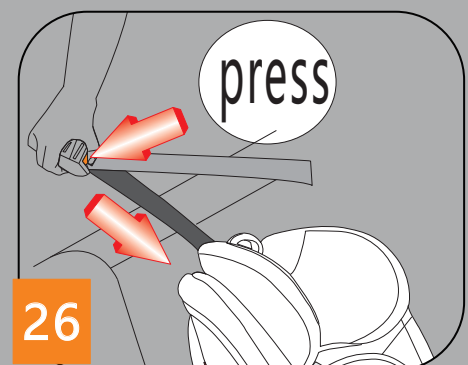

COZYNSAFE



6.3.2.3. Put the top tether through the vehicle headrest. Then hook it onto the vehicle top tether anchorage according to the vehicle manual. (fig. 27)

6.3.2.4. Hold the end of the belt and pull out until the belt is tight enough (the green indicator will appear). (fig. 28)

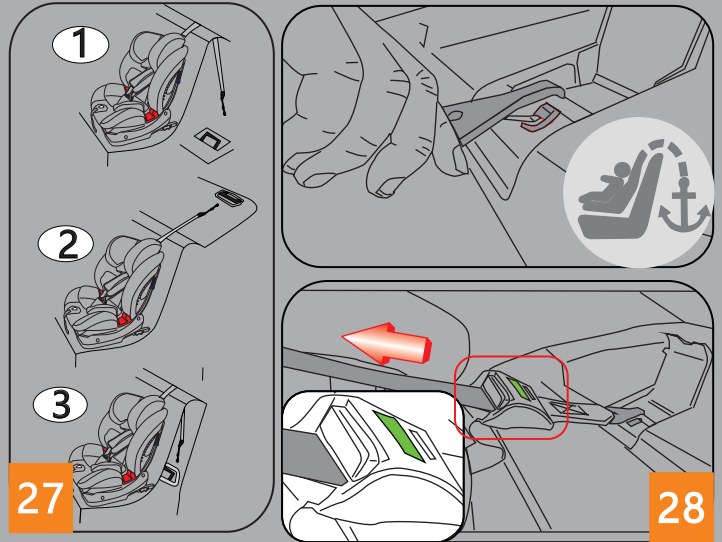

Finally check the child seat is fitted stable on the vehicle seat. If you find any movement you must tighten the top tether again until the child seat is tight enough.

6.3.3. Installation of child: Refer the (chapter 7.1) to fit your child carefully to finish the installation.

7. Securing the child

7.1. Securing the child in the Group. 0+ (0 – 13 kg), Group. I (9 – 18 kg).

When your child's weight is between 0-18kg. Use the 5 point harness to fit your child in the seat. Follow the steps below;

7.1.1. Relax the harness before adjust the height. The harness is loosened by pressing the adjuster on the front of the seat. Press down the adjuster as you grip the two shoulder straps with your other hand. Pull the shoulder straps towards you to loosen the harness. (fig. 29)

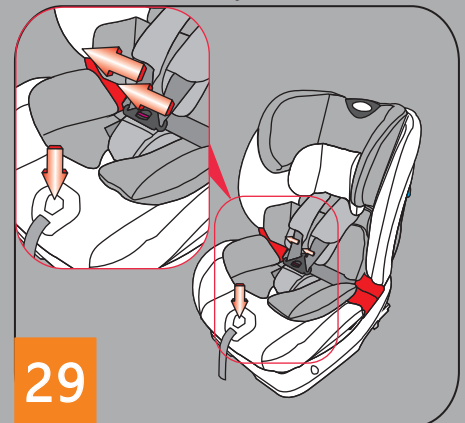

7.1.2. Relax the buckle: push down the red button on the buckle, the buckle tongue will jump out. Then put the harness at the both side of seat. (fig. 30)

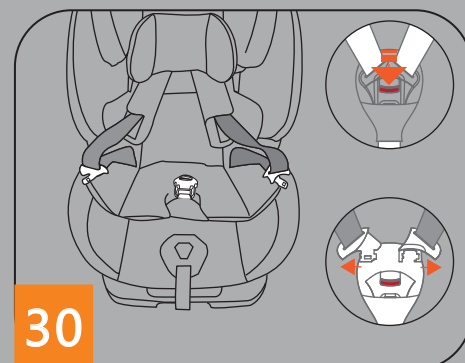

COZYSAFE



7.1.3. Put your child into the child seat, put the buckle (part no.10 page 01) on the front of your child's crotch. Make your child's arms are through the shoulder belts, ensure that the shoulder belts and pads are just on top of your child's shoulders. (fig. 31)

Adjust the harness and headrest height refer to (chapter 4.4). The top of the shoulder belt must be parallel or a little higher than the child's shoulders. Too high or too low is not recommended.

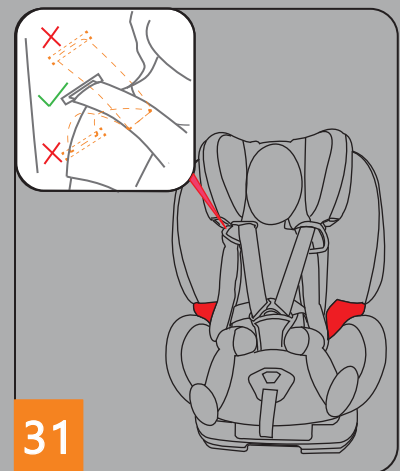

7.1.4. Reassemble buckle until you hear a "click". (fig. 32)

7.1.5. Pull back the harness adjust strap tighten the harness. To be sure there should not be more than a fingers width between the harness and your child. It is most important to ensure that any lap strap is worn low down, so that the pelvis is firmly engaged. (fig. 33)

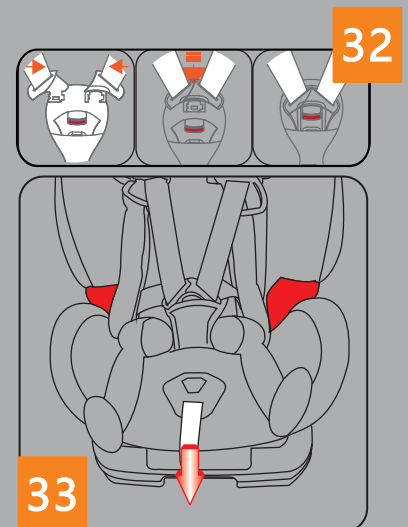

Notice: If the harness is too tight, please relax it then adjust it again.

7.2 Securing the child in the group II, III (15 – 36 kg)

Important: When your child's weight is more than 15kg, you can use the vehicle's 3 point belt to fit your child directly.

7.2.1 Remove the harness

7.2.1.1. Relax the harness. (fig. 34)

7.2.1.2. Turn to the back of your child seat ,push down the instruction box button and at the same time pull out the box. (fig.35)

7.2.1.3. Pull out the adjuster belt and release the two shoulder belts from the metal connector. (fig. 36)

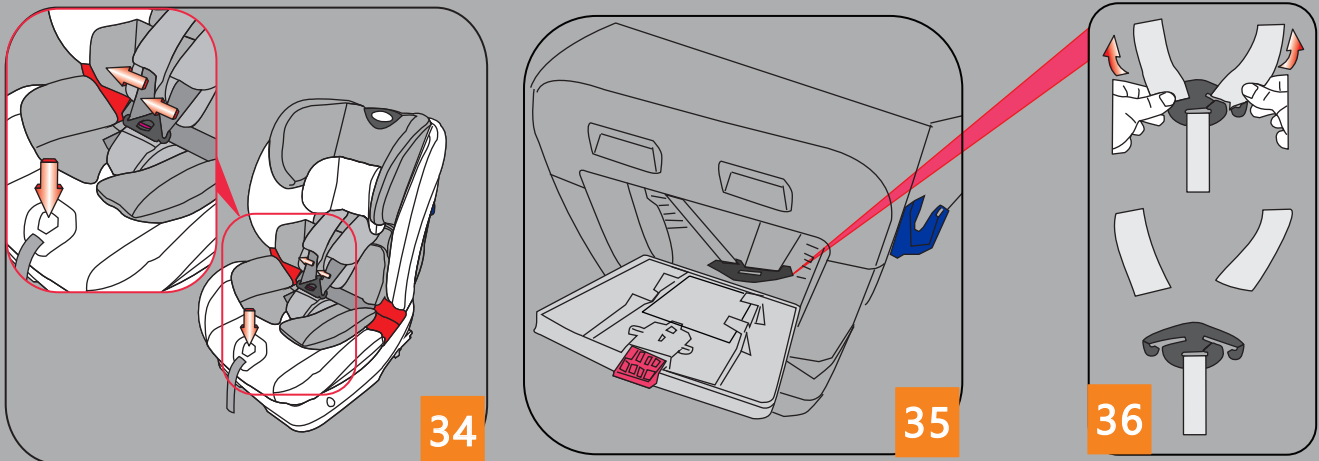

7.2.1.4. Release the shoulder pad from the 6-shape metal connector. (fig. 37)

7.2.1.5. Pull out the shoulder pads. (fig. 38)

7.2.1.6. Twist the crotch belt and make the corner align to the front slot then pull out the metal to release the buckle and crotch belt. (fig. 39)

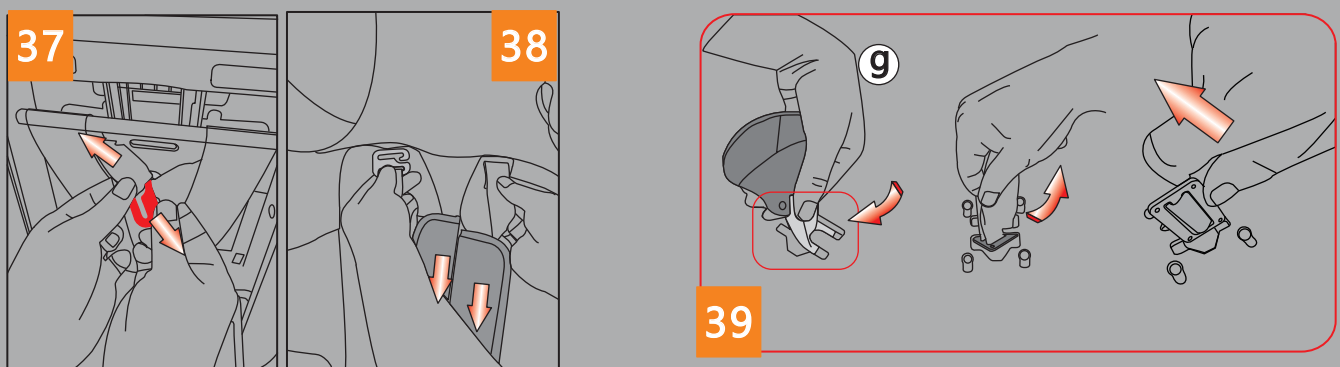

7.2.2. Seat installation

It can be used forward facing only at Group II, III.

The ISOFIX connector is an optional for Group II, III. If it is connected to the ISOFIX anchor point on the vehicle seat or not. (fig. 23 on page 14).

7.2.2.1. First Refer to chapter 4.2 to adjust the seat angle to the right position.

7.2.2.2. Then Refer to chapter 5.1 Put the child seat on to the vehicle seat, make sure the backrest of the child seat is firmly pressed against the backrest of vehicle seat.

7.2.3. Fit your child

7.2.3.1. Let your child sit on the child seat, make sure your child's back is against the backrest. (fig.10 on page 10)

7.2.3.2. Adjust the height of the headrest, the space between the top of child's shoulder and the bottom of the headrest should be just two fingers apart.

7.2.3.3. Extend the vehicle belt to the maximum, move the belt around in front of your child. And insert the buckle tongue into the vehicle buckle, and hear a "click". (fig. 39, 40)

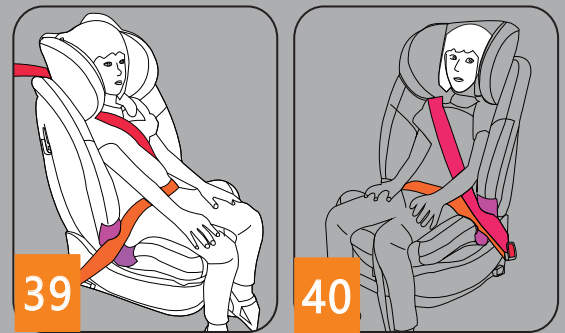

7.2.3.4. Insert the diagonal belt into the red belt guide on the bottom of the headrest. (fig. 41)

7.2.3.5. Adjust the vehicle belt's lap section. It is most important to ensure that any lap strap is worn low down, so that the pelvis is firmly engaged.

7.2.3.6. Pull the diagonal belt at the top of the vehicle buckle make the belt tight. (fig. 41)

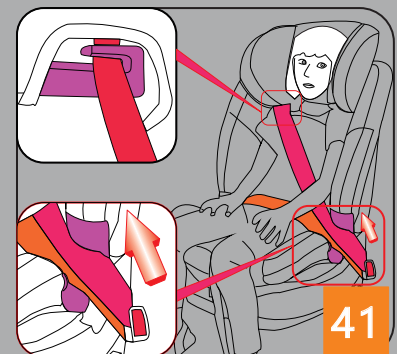

7.2.3.7. Then pull the diagonal belt at the top of the seat as indicated as tight as you can. (fig. 42)

7.2.3.8. Finally check the child seat is fitted stable on the vehicle seat.

If you find any any movement you must tighten the belt again until the child seat is tight enough.

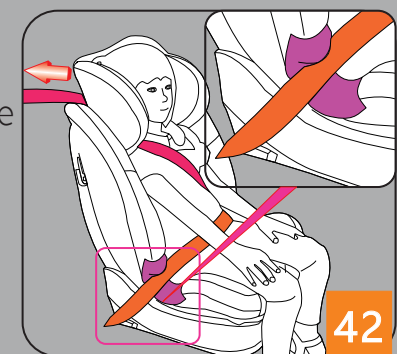

8. Removing and replacing the cover

The fabric cover on this seat can be removed for washing. It just needs to be pulled out at the fringe of the seat (fig. 43). After washing you can assemble it to the seat again.

The seat cover is an integral part of the child seat. The child restraint must not be used without the cover.

The seat cover should not be replaced with any other than the one recommended by the manufacturer, because the cover constitutes an integral part of the restraint performance.

Suggestion: Do not wash the fabric frequently. It must assemble in its original state after washing.

To replace the cover, follow the steps for removing the cover in reverse order

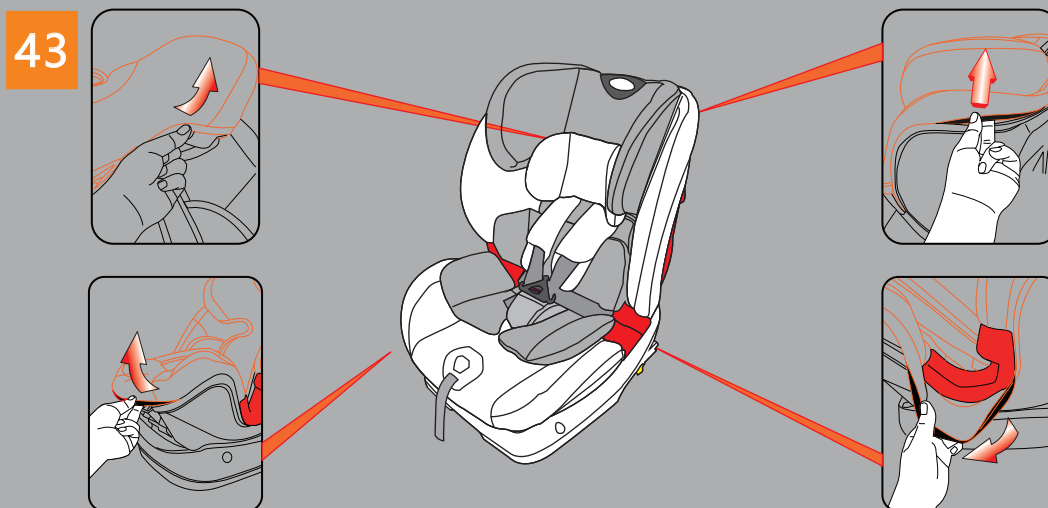

9. Washing and maintenance

Check if there is any part that is missing or broken, if this is the case, do not use the seat again.

9.1. Fabric:

Fabric can be washed in temperatures less than 30 °C. Then dry by nature condition.

9.2. Belt and plastic:

Wash with warm water and mild soap, do not use solvents or high-potency soap, do not remove or change fabric or any part of the harness.

9.3. Buckle:

Always check that there is no food debris, lint or other such matter in the harness buckle. This may affect the correct function of the buckle please clean it by warm water. You can hear a "click" when the buckle function is normal.

COZY N SAFE



10. Steps to take after an accident

After an accident with an impact speed greater than 10 km/h, the child restraint system must be replaced without fail. There may be hidden damages.

11. Warranty

For the seat we extend a warranty against defects in materials and workmanship for up to one year.

The warranty period begins on the date of purchase.

A receipt is required for all claims.

The warranty covers child restraint systems that have been handled properly and are returned in a clean and orderly condition.

The warranty does not cover:

- Normal wear and tear and damage due to unreasonable use
- Damages due to improper or inordinate usage.

Fabrics: All of our fabrics meet the highest standards regarding colourfastness against UV radiation. Nevertheless, all fabrics fade when exposed to UV radiation.













This is not due to defective material but to normal wear and tear, which is not covered by the warranty.

Please contact your specialist dealer immediately in the event of warranty claim.

COZY  SAFE



12. Fit list

- * Since product year
-  No top
-  With toptether
-  With 3 point belt
-  Quantity of vehicle doors
-  Quantity of seat
-  Mobile vehicle
-  Estate car
-  Ragtop
-  Hatchbacks
-  Multi-Purpose Vehicle
-  Coupe
-  Check if the vehicle has suitable anchor

② 4 ... (suitable seat)

- a) Starting from the model has in the market
- b) Starting from the model has in the assemble line
- c) Week of natural
 - 1) The rear seat if it's electric, cannot be used in the back of this seat, if it is manual you can use it.
 - 2) ISOFIX anchor point of some old models are potential, if not installed ISOFIX anchor, the ISOFIX function cannot be used.
 - 3) The mode of special (can be obtained from car dealers only)
 - 4) Double bench seat
 - 7) Only when apply after installing additional foam pad. The attachment is obtained from the auto retailer.

COZY  SAFE[®]
a R T H u R